

RAMVAC

by SEWER EQUIPMENT



HX TRUCK SERIES

BEST PRODUCTS, BEST LOCAL SUPPORT



HX TRUCK SERIES

The RAMVAC truck-mounted vacuum excavator is built from the ground up to be the safest, simplest and most maneuverable vacuum excavator on the market. When RAMVAC engineers began designing the HX truck mounted series, they called on end users like you to help them understand what is important in the field and on the road.



RAMVAC understands that operators need a truck that can be easily maintained in the field with parts that are locally available. The trucks in the HX series are made with easily understood electrical systems and do not rely on complex computer systems. Owners are looking for a competitive advantage and RAMVAC offers trucks with better fuel economy and more reliable drive systems.

RAMVAC HX truck series come equipped with many exclusive features that set it apart from its competition. The exclusive temperature controlled environmental chamber protects against water system freezing. This allows you to utilize the truck in all climates, whether it be in an oilfield in South Texas or in the Canadian Tar Sands. This enclosure also provides security for all components inside the chamber. The design of the RAMVAC HX series ensures one of the smallest footprints in the industry, allowing operators to maneuver in and out of areas that competitor trucks cannot.

The air filtration system is another key to RAMVAC's industry leading performance. Its design delivers high performance air movement and maximum blower protection. RAMVAC's standard Dig Deep boom increases operator productivity by providing the ability to dig 13 feet below grade utilizing one standard vacuum tube.

With a number of available options, the RAMVAC HX series can be customized to meet the needs of any operator. RAMVAC's HX series trucks are available with 3,000 to 5,400 CFM blowers, 6" and 8" systems, 3 yard to 15 yard debris tanks and transfer case or hydrostatic drive. RAMVAC's Central Lubrication System and additional available 800,000 BTU water heater are features that set RAMVAC apart from the competition while helping operators get the job done right the first time.

Our goal is to build a truck for you, that not only meets your needs, but exceeds your expectations. RAMVAC puts operator safety and simplicity at the top of the list and is committed to building machines of the highest caliber to ensure the quality performance you require to reduce down time and keep you profitable.

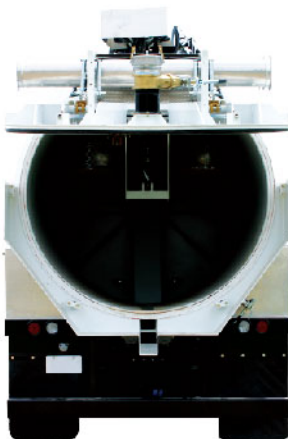

TOLL FREE 800.323.1604

HX TRUCK SERIES



RAMVAC's boom features a 5' extension for a total reach up to 26' from the truck. Worm gear driven, with access to the receiver box, and a abrasion-resistant steel at the back to absorb the impact from bulk material. RAMVAC's standard "dig deep" boom provides operators the ability to dig 13 feet below grade utilizing one standard vacuum tube.



The Temperature Controlled Environmental Chamber is a RAMVAC Exclusive feature. The entire water system is enclosed in this insulated, heated compartment. From the moment the water enters the top of the tanks until the moment it leaves the hose reel, every component from tank to pump are heated by our 80,000 BTU heater.



RAMVAC HX trucks come standard with locking differentials and power diverters to help you get out of the most difficult terrain. Its design ensures one of the smallest footprints in the industry, allowing you to get into those tight spots where other hydro excavators will not fit.



RAMVAC Hydro Excavator's drive system includes fail safes that other manufacturers do not. The truck series is equipped with independent drive systems for the blower, the water system and auxiliary hydraulics to ensure less wear and tear, as well as system separation.



RAMVAC features a NEMA 4 electrical system, including a dust and water resistant control panel, rubber booted and o-ringed controls, loomed wiring, sealed automotive style connections and junctions, as well as a common electrical ground.



RAMVAC Air System

The RAMVAC Air System is the secret behind our industry leading performance. The RAMVAC Air System is designed to deliver industry leading air movement, while providing the maximum protection for your blower.

The first stage in the RAMVAC Air System is air flow through the boom. The material will impact the back of the receiver box and start to drop into the tank. As the material enters the tank, it is directed toward the front of the tank to provide for even distribution. The air entering the tank along with the material is routed from the single 8" entry point to dual 8" exit points located at each side of the entry. Thus slowing down the air flow and improving material separation.

The second stage of the RAMVAC Air System takes the air from the tank and routes it into our cyclone filters. At this point the cyclonic action of these filters propels any remaining material to the side walls of the filters and then down in to an easily maintained collection box.

In the third stage of the RAMVAC Air System, the air moves from the cyclone filter into the dual 10 micron final filters. These washable filters will capture any fine particles remaining in the air stream before allowing the air to pass through the positive displacement blower.

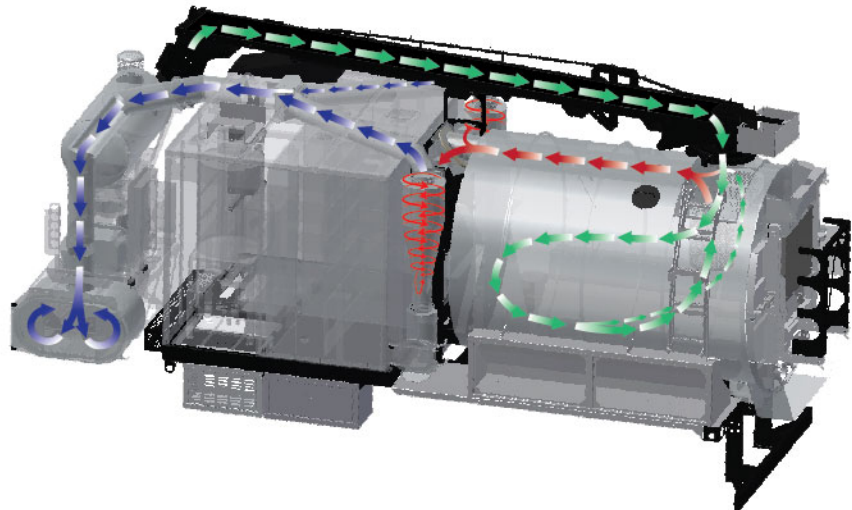

BEST PRODUCTS, BEST LOCAL SUPPORT

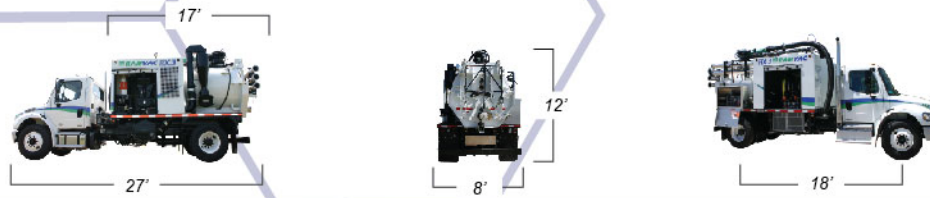

| MODEL | LENGTH | WIDTH | HEIGHT | WEIGHT EMPTY | GVWR | BOOM REACH | CAPACITY | MIN HP | AXLE CONFIGURATIONS |
|------------|--------|-------|--------|--------------|------------|------------|----------|--------|-----------------------|
| HX3 | 27' | 8' | 12' | 23,800lbs. | 33,000lbs. | 11'-16' | 3yd | 300hp | Single or Tandem Axle |

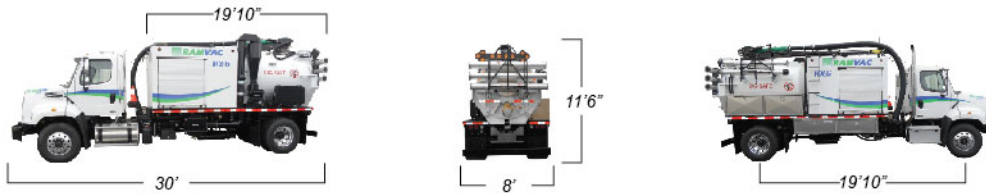

| MODEL | LENGTH | WIDTH | HEIGHT | WEIGHT EMPTY | GVWR | BOOM REACH | CAPACITY | MIN HP | AXLE CONFIGURATIONS |
|------------|--------|-------|--------|--------------|------------|------------|----------|--------|-----------------------|
| HX6 | 30' | 8' | 12' | 27,040lbs. | 39,000lbs. | 13'-18' | 6yd | 300hp | Single or Tandem Axle |

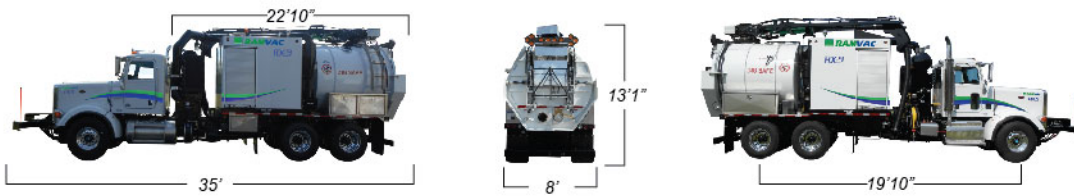

| MODEL | LENGTH | WIDTH | HEIGHT | WEIGHT EMPTY | GVWR | BOOM REACH | CAPACITY | MIN HP | AXLE CONFIGURATIONS |
|------------|--------|-------|--------|--------------|------------|------------|----------|--------|-----------------------------|
| HX9 | 35' | 8' | 13'1" | 38,300lbs. | 66,000lbs. | 15'-20' | 9yd | 425hp | Tandem, Pusher, or Tri Axle |

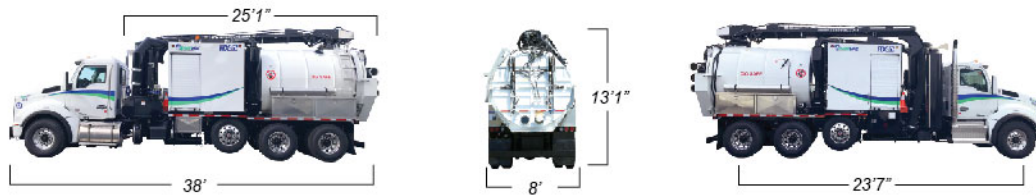

| MODEL | LENGTH | WIDTH | HEIGHT | WEIGHT EMPTY | GVWR | BOOM Reach | CAPACITY | MIN HP | AXLE CONFIGURATIONS |
|-------------|--------|-------|--------|--------------|------------|------------|----------|--------|-----------------------------|
| HX12 | 38' | 8' | 13'1" | 43,030lbs. | 79,200lbs. | 18'-23' | 12yd | 425hp | Tandem, Pusher, or Tri Axle |

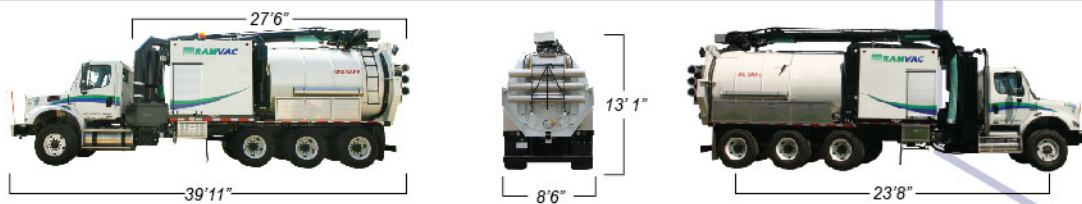

| MODEL | LENGTH | WIDTH | HEIGHT | WEIGHT EMPTY | GVWR | BOOM Reach | CAPACITY | MIN HP | AXLE CONFIGURATIONS |
|-------------|--------|-------|--------|--------------|------------|------------|----------|--------|---------------------|
| HX15 | 40' | 8'6" | 13'1" | 46,500lbs. | 88,000lbs. | 21'-26' | 15yd | 425hp | Tri Axle |

TOLL FREE 800.323.1604

HX TRUCK SERIES

HX-3 HX-6 HX-9 HX-12 HX-15

| Temperature Controlled Environmental Chamber | | | | | |
|---|---|---|---|---|---|
| Steel Construction | S | S | S | S | S |
| Aluminum Construction | O | O | O | O | O |
| Insulation System | O | O | O | O | O |
| "Polar Pack" Insulation System | O | O | O | O | O |
| 80,000 BTU Heater | S | S | S | S | S |
| Heated Equipment Locker | S | S | S | S | S |
| Boom Assembly | | | | | |
| 6-Way Hydraulic Assist | S | S | S | S | S |
| Dig Deep Boom | S | S | S | S | S |
| 320 Degree Working Radius | S | S | S | S | S |
| Replaceable Wear Plate | S | S | S | S | S |
| Easy Access Inspection Port | S | S | S | S | S |
| Telescoping Boom | | | O | O | O |
| Chassis | | | | | |
| Single Axle Configuration | S | S | | | |
| Tandem Axle Configuration | O | O | S | | |
| Tandem Axle w/ Pusher Configuration | | | | S | |
| Tridem Axle Configuration | | | | O | S |
| LED ICC Lighting | S | S | S | S | S |
| No Sail Mud Flaps | | S | S | S | S |
| Hitch w/ Brake Controller | O | O | O | O | O |
| Vacuum System | | | | | |
| 3000 CFM and 18" | S | S | O | O | O |
| 4400 CFM and 18" | | | S | S | S |
| 5400 CFM and 28" | | | O | O | O |
| 6" Vacuum System | S | S | | | |
| 8" Vacuum System | | | S | S | S |
| Cyclone Separation | S | S | S | S | S |
| 10 Micron Final Filter | S | S | S | S | S |
| Vacuum Enhancer | S | S | S | O | O |
| Directional Discharge | S | S | S | O | O |
| Hydrostatic Blower Drive | S | S | S | O | O |
| Tool Boxes & Storage | | | | | |
| Deck Mounted Aluminum Tool Box Driver Side | | | S | S | S |
| Deck Mounted Aluminum Tool Box Passenger Side | S | S | S | S | S |
| Below Deck Mounted Aluminum Tool Box Driver Side | | | S | S | S |
| Below Deck Mounted Aluminum Tool Box Passenger Side | | S | S | S | S |
| Deck Mounted Steel Tool Tray | O | O | O | O | O |
| Behind Cab Tool Tray | S | S | O | O | O |

| Legend | |
|----------|---|
| Standard | S |
| Optional | O |

HX-3 HX-6 HX-9 HX-12 HX-15

| Excavation System Attachments & Accessories | | | | | |
|--|---|---|---|---|---|
| 185 CFM @ 150 psi Air System | O | O | O | O | O |
| Additional Air Lance | O | O | O | O | O |
| Additional Water Lance | O | O | O | O | O |
| Debris Box | | | | | |
| 1/4" EX-TEN Steel Construction | S | S | S | S | S |
| Debris Liquid Level Indicator | S | S | S | S | S |
| 50 Degree Hydraulic Dumping | S | S | S | S | S |
| Fold Down Pipe Racks | S | S | S | S | S |
| Hydraulic Open/Close Rear Door | S | S | S | S | S |
| Electric Body Vibrator | O | O | O | O | O |
| Audible Liquid Level Alarm | O | O | O | O | O |
| 8" Sampling Port w/ Ladder | | | S | S | S |
| Dual 6" Ported Rear Door | | | S | S | S |
| 4" Hydraulic Trash Pump (800 GPM) | | | O | O | O |
| 3" Hydraulic Trash Pump (400 GPM) | O | O | | | |
| Central Lubrication System | O | O | O | O | O |
| Electrical & Lighting | | | | | |
| NEMA 4 Rated Control Box | S | S | S | S | S |
| Wireless Remote | S | S | S | S | S |
| Tethered Remote | O | O | O | O | O |
| Water System | | | | | |
| 325 Gallon Water Capacity | S | | | | |
| 650 Gallon Water Capacity | | S | | | |
| 1300 Gallon Water Capacity | | | S | S | S |
| 10 GPM @ 2500 psi Pump | S | S | S | S | S |
| 18 GPM @ 2500 psi Pump | O | O | O | O | O |
| 400,000 BTU Water Heater | S | S | S | S | S |
| 800,000 BTU Water Heater | O | O | O | O | O |
| 2.5" Water Fill | S | S | S | S | S |
| "Y" Strainer Water Fill Filter | O | O | O | O | O |
| Water Recirculation System | S | S | S | S | S |
| Heated Hand Wash System | S | S | S | S | S |
| 75' of 3/8" Hose w/ Spring Load Retractable Reel | S | S | S | S | S |
| Anti-Freeze System (10 Gallons) | O | O | O | O | O |
| Inlet Misting System | O | O | O | O | O |
| Dual Operator Station | O | O | O | O | O |
| Air Purge System (Chassis Powered) | O | O | O | O | O |
| Accessories | | | | | |
| Extension Tube Kit | S | S | S | S | S |
| Digging Tube w/ Insulation | S | S | S | S | S |
| Quick Clamp Kit | S | S | S | S | S |
| Rotary Head Digging Wand | S | S | S | S | S |
| Dual Nozzle Chisel Head Wand | S | S | S | S | S |
| Washdown Gun | S | S | S | S | S |
| 25' Fill Hose | S | S | S | S | S |
| Hydrant Wrench | S | S | S | S | S |
| Owner's Manual (Paper & CD) | S | S | S | S | S |
| Safety Cones w/ Rack | O | O | O | O | O |



Revised 11/19

Contents are copyrighted by Sewer Equipment Company of America

Products subject to change without notification.

Actual products may not be an exact match to product as shown.

800.323.1604
www.sewerequipment.com

